

Design Guidelines for
**Cranbury Village
Historic District & Sites**



Township of Cranbury, New Jersey

"Design Guidelines for Cranbury Village Historic District and Sites," Cranbury Township Historic Preservation Commission, 2011.
<http://www.cranburytownship.org/documents/DesignGuidelines-2011.pdf>
(Accessed July 19, 2017)

TOWNSHIP OF CRANBURY, NEW JERSEY

**DESIGN GUIDELINES
FOR**

**CRANBURY VILLAGE HISTORIC DISTRICT
& SITES**

Township Committee

Winthrop Cody, Mayor
David Cook
Glenn Johnson
Dan Mulligan
James Taylor



Historic Preservation Commission

Bobbie Marlowe, Chair
Diane Stasi, Vice Chair
Debbie Driscoll, 2nd Alternate
Wayne Girardet
Allan Kehrt, 1st Alternate
Harry Williams
John Ziegler

HPC acknowledges and appreciates past Township Committee members Thomas Panconi Jr., Richard Stannard, Pari Stave, David Stout, and Wayne Wittman and past HPC members Cynthia Hinson, Kate McConnell, Frank McDonald, Alana Stops, and Don Jo Swanagan for their support, encouragement, and expertise.

Cranbury Township Historic Preservation Commission

Township of Cranbury
23-A North Main Street, Cranbury, New Jersey 08512

www.cranburytownship.org

Prepared by
Gail L. Hunton, Historic Preservation Consultant

2007-2011

*Ordinance No. 01-06-02
Adopted February 27, 2006*

TABLE OF CONTENTS

HISTORIC PRESERVATION IN CRANBURY

Overview of Historic Preservation in Cranbury	1
Map of Historic District	2
The Cranbury Historic Preservation Commission (HPC)	3
HPC Approval for Your Project	3
Planning Your Building Project	4

CRANBURY'S HISTORIC BUILDINGS.....5-24

DESIGN GUIDELINES FOR REPAIRS, ADDITIONS AND NEW CONSTRUCTION

.....	25
The Principles of Preservation: The Secretary of the Interior's Standards	26
Site and Streetscape	27-28
Additions and New Construction	29
Exterior Materials.....	30-32
Roofs.....	33-34
Windows	35-36
Doors	37-38
Porches.....	39
Trim	40
Storefronts.....	41
Paint	42

HELPFUL INFORMATION

Choosing an Appropriate Treatment for Your Historic Building.....	43
Organizations to Guide You	44
Publications	45
Glossary of Architectural Terms	46-48

PURPOSE AND OVERVIEW

PURPOSE OF THE DESIGN GUIDELINES

Design Guidelines for Cranbury Village Historic District and Sites are intended to further appreciation of Cranbury's historic buildings and places, to ensure consistency in local decision-making, and to benefit property owners by clarifying community expectations. The Design Guidelines were written and adopted to assist the Historic Preservation Commission (HPC) in its review of proposed additions, alterations and new construction in the historic district, and to guide property owners in planning and designing their construction projects.

Design guidelines can provide an objective basis for the Commission's decisions, can increase public awareness of historically appropriate design, and discourage the worst kind of insensitive building. Good quality design, however, cannot be achieved through the application of a set of rules. The challenge for the HPC and property owners alike is knowing how to use the design guidelines to make sound judgments that will preserve our historic resources, while allowing expressions of change and adaptation.



OVERVIEW OF THE DESIGN GUIDELINES

The first chapter, *Historic Preservation in Cranbury*, provides background on Cranbury's historic community character and the Township's historic preservation efforts. You will also find information on the Historic Preservation Commission (HPC) and when a HPC Certificate of Approval is required, as well as helpful advice on planning your project. *Cranbury's Historic Buildings* describes and illustrates the prevalent building styles and patterns in Cranbury, and serves as an architectural guide to the Township's historic resources. The design guidelines themselves are found in the chapter titled *Design Guidelines for Repairs, Additions and New Construction*, and cover work on existing buildings as well as new construction. At the end of the book, in *Helpful Information*, you will find reference material on choosing an appropriate treatment for your historic building; lists of organizations, websites, and publications for more information about historic preservation and Cranbury's history; and a glossary of architectural terms.

Illustration Credits:

Color photographs are by Gail Hunton.

Architectural drawings are drawn from a variety of public domain sources, including the Historic American Buildings Survey, Library of Congress; the Sears Roebuck Archives; and reprints of historic building pattern books.

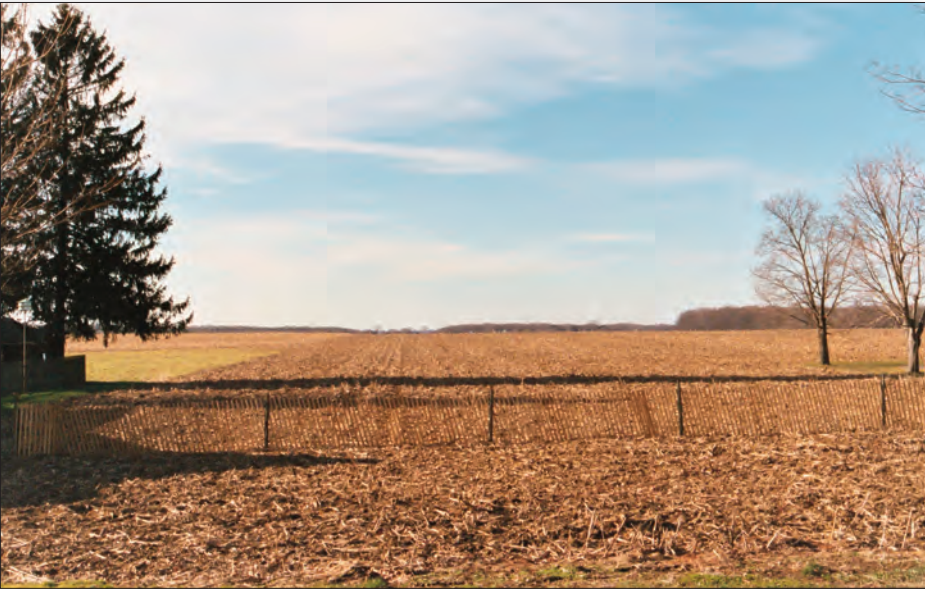



HISTORIC PRESERVATION IN CRANBURY

The village of Cranbury, located on the fertile Inner Coastal Plain of central New Jersey, halfway between Philadelphia and New York, is historically similar to many crossroads villages that once dotted New Jersey's countryside. Relatively small and compact, the village is clustered along the length of a historic main road and on branching side streets. Although the village origins date to the 1680's, the houses, shops, churches and schools in the village date largely from the period between 1830 and 1930, with several buildings dating from the late 18th century. An early inn, grist miller's house, and millpond stand as reminders of the village's economic origins as a way stop and mill village on the Great Post Road at Cranbury Brook and the Millstone River. The building pattern and architecture of the village define its historic identity, while the rural setting in which the village developed is equally fundamental to its character, with a well-defined edge between the cluster of buildings in the village and open farmland.

While many of New Jersey's historic villages have been overwhelmed by later development or have disappeared altogether, Cranbury has not only survived but has thrived. Its sense of place has prevailed even as the village has grown and changed, and there is a healthy balance between the individuality of the buildings and the community of the street.

Cranbury's preservation is no accident. The community has recognized the importance of its heritage through sound planning and active programs to preserve its historic resources and farmland. Spearheaded by the Cranbury Historical and Preservation Society, the Cranbury Village Historic District was listed on the New Jersey Register of Historic Places in 1979 and on the



National Register of Historic Places in 1980. The Township enacted a municipal historic preservation ordinance in 1989 to create a local historic district in Cranbury Village and to establish a Historic Preservation Advisory Committee (HPAC) to review building projects within the district. In 2006 the Township revised the municipal code to establish the current Historic Preservation Commission and to adopt these Design Guidelines.

The Township also has a progressive Master Plan that incorporates historic preservation on equal standing with other community planning concerns. Working with the county and state farmland preservation programs, Cranbury has permanently preserved more than 2,410 acres of farmland west of the village, thus protecting agriculture as well as the historic rural setting.

Lastly, the Township has taken a leadership role in its stewardship of publicly owned historic buildings. The 1896 Cranbury School has been handsomely rehabilitated for township offices, and the restored grist miller's house serves as the home of the Cranbury History Center operated by the Cranbury Historical and Preservation Society.

"Design Guidelines for Cranbury Village Historic District and Sites" is the latest effort to advance historic preservation in Cranbury. These guidelines were written and adopted to assist the Historic Preservation Commission (HPC) in its review of proposed work on properties in the historic district, and to guide property owners in planning and designing their construction projects. The guidelines are intended to further appreciation of Cranbury's historic buildings and places, to ensure consistency in local decision making, and to benefit property owners by clarifying community expectations.

HISTORIC PRESERVATION IN CRANBURY

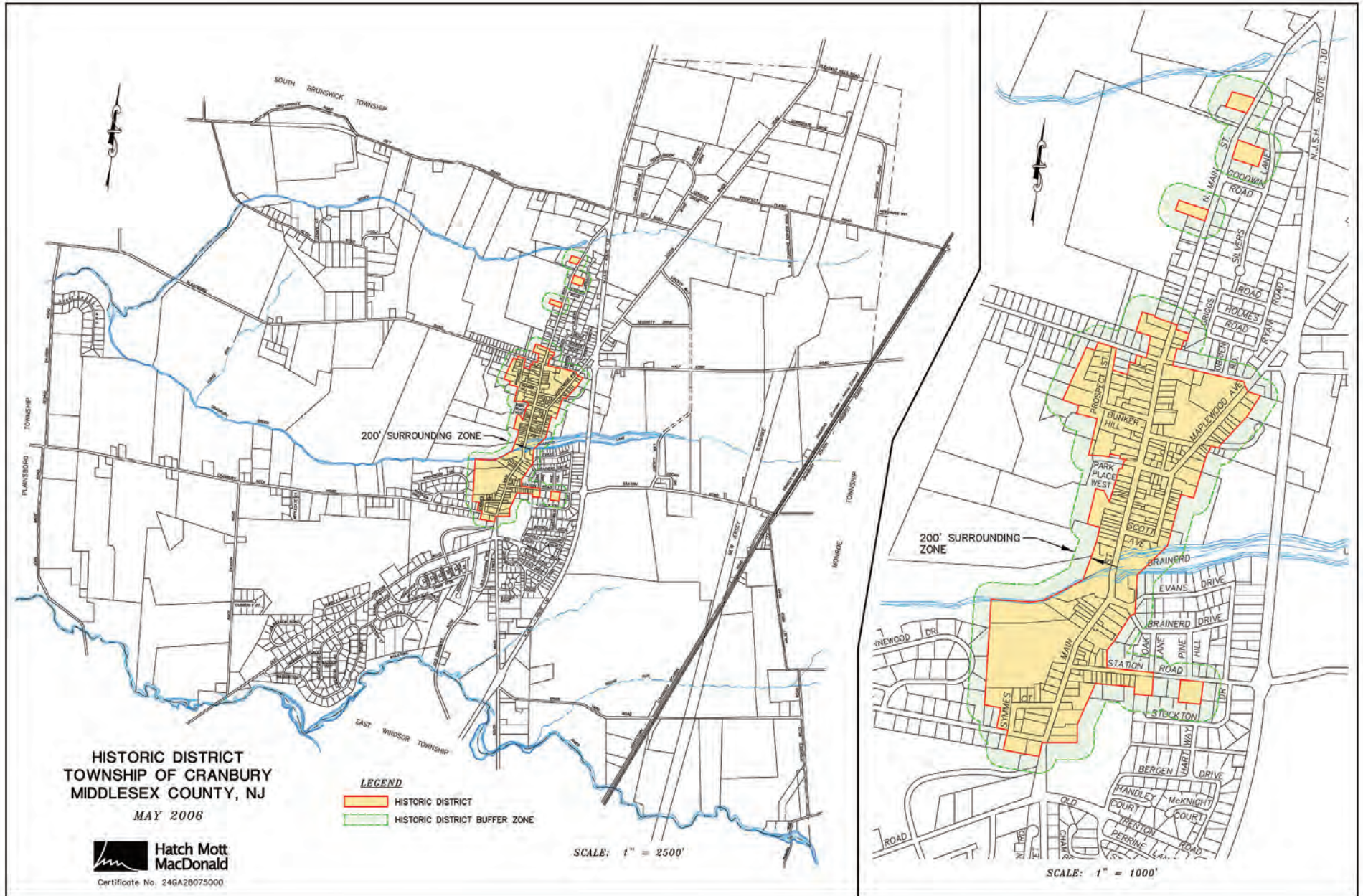

HISTORIC PRESERVATION IN CRANBURY

THE CRANBURY HISTORIC PRESERVATION COMMISSION

The Cranbury Historic Preservation Commission (HPC) was established by municipal ordinance to safeguard the heritage of the Township by preserving resources that reflect elements of the Township's cultural, social, agricultural, economic, archeological, scenic and architectural history.

The HPC is charged with the following duties and responsibilities: Identify, record and maintain a system for survey and inventory of all buildings, sites, places, landmarks and structures of historical or architectural significance.

Propose sites and districts to the Planning Board and Township Committee that are worthy of historic designation.

Make recommendations to the Planning Board regarding the historic preservation element of the Master Plan and the impact of each component of the Master Plan on the preservation of historic sites and districts.

Advise the Planning Board and Zoning Board of Adjustment on applications for development that impact designated historic properties.

Review applications and issue Certificates of Approval for proposed repairs, additions, alterations, new construction, demolition and relocation within a historic district or historic buffer area or on a historic site.

Comprised of seven volunteer citizen members appointed by the Township Committee, HPC members have expertise in architectural design, construction, and local history. The Commission strives to assist applicants with their projects, and encourages applicants to meet informally with the HPC prior to submitting an application, particularly if the project is a large addition or new construction. The Commission's meeting schedule is posted at the Township Offices and on the Township website.

HPC CERTIFICATE OF APPROVAL FOR YOUR PROJECT

The HPC issues Certificates of Approval if it finds that the application conforms to the Design Guidelines and the historic preservation ordinance. Applications and procedures for obtaining a Certificate of Approval are available at the Township Offices and on the Township website.

A Certificate of Approval issued by the HPC is **required** if a property is located within a historic district or historic buffer area or on a historic site before work can begin for any of the following activities:

- Demolition or relocation of any building, improvement, or structure.
- Change in the exterior appearance of any building, improvement, site, place or structure by addition, reconstruction, alteration or repair, other than ordinary maintenance and repair as defined in Chapter 93 of the municipal code.
- Any addition to or new construction of a principal or accessory building or structure.
- Any addition of signs or exterior lighting or changes to same.

A Certificate of Approval is **not** required for any of the following:

- Changes to the interior of structures.
- Changes to the exterior of structures that strictly meet the standards for ordinary maintenance and repair as defined in Chapter 93 of the municipal code.
- Emergency repairs, under limited circumstances as defined in Chapter 93 of the municipal code.

HISTORIC PRESERVATION IN CRANBURY



“The Historic Preservation Commission (HPC) is vital to Cranbury if we are to continue to safeguard its historic character and to protect its noteworthy buildings and streetscapes from inappropriate changes and ultimate loss of significance and character. If indeed we are proud to live in a community such as ours, we must be constantly aware and vigilant for its preservation. We can best do this by helping the HPC in whatever way we can to carry out their responsibility to preserve our historic integrity. Then we shall continue to be ‘the best preserved village in Middlesex County.’”

— Elizabeth (Betty) Wagner, Cranbury Township Historian

Planning Your Building Project

- 1. Check Available Documentation.** Knowing the history of your building can help you make informed decisions about your project. Check with the Historic Preservation Commission office, the Cranbury History Center and other sources to find out about your building’s origins and changes over time, and to see photographs and views of the building in the past.
- 2. Consult Preservation Publications.** There is a wealth of readily available material in libraries and on the web on preservation do’s and don’ts, as well as practical guidance on repair techniques and where to find products and materials for historic buildings. (See “Helpful Information”) Learn from the experience of others so you don’t make mistakes!
- 3. Evaluate the Historic Character and Physical Condition of the Building.** Identify the materials and features of the building that contribute to its historic character, and that need to be preserved. Are there any physical problems that threaten the structure? Are there historic features hidden behind later alterations?
- 4. Plan for the Work.** Hire an architect or contractor who has experience with historic building work. Review the Design Guidelines, and consult with the HPC before you complete your designs to make sure that your project will meet the Design Guidelines.

CRANBURY'S HISTORIC BUILDINGS



CRANBURY'S HISTORIC BUILDINGS



CRANBURY'S HISTORIC BUILDINGS



Cranbury's houses, barns, churches, shops and public buildings are representative of more than a chronology of architectural styles. They represent three centuries of creating home and community in Cranbury. These buildings are sited along streets that reflect the early land division of the town, clustered along early transportation routes and near a grist mill and spice mill on Cranbury Brook.

Understanding building traditions and styles is the foundation for appreciating the historic character of Cranbury Village. Awareness of what gives a building its historic character allows us to take these features into account and treat them with sensitivity when we undertake a repair, addition or new construction.

What follows is a brief overview of the major building traditions and architectural styles found in Cranbury, beginning with the earliest surviving buildings from the late 18th century and ending with the mid 20th century structures. This is intended as a practical guide for identifying the forms



CRANBURY'S HISTORIC BUILDINGS

and fashions of buildings in Cranbury, indicating when they were popular and their significant identifying features.

Many buildings reflect combinations of styles rather than pure textbook examples. Alterations and additions over the years also may confound efforts to neatly label a building's style.

There are many excellent guides and books on American architecture, but a comprehensive book on New Jersey's distinctive building traditions has not yet been written. The sources below are particularly useful for understanding Cranbury's architectural heritage. In addition to consulting architectural reference books, your local library, the Cranbury Historical and Preservation Society, and the Historic Preservation Office in Town Hall have collections of books, documents and photographs that can assist you in understanding the history and design of your building and your town.

Virginia and Lee McAlester, *A Field Guide to American Houses* (Alfred A. Knopf, 1984).

Robert Guter and Janet Foster, *Building by the Book: Pattern Book Architecture in New Jersey* (Rutgers University Press, 1992).

Alan Gowans, *The Comfortable House: North American Suburban Architecture* (M.I.T. Press, 1986).



VILLAGE VERNACULAR



The history of architecture in Cranbury begins with the English settlers who used and adapted their north European building traditions to construct their own houses, barns, shops, and churches. These buildings are the work of local carpenters, and are called “vernacular” because, like a dialect, they are the product of local people in a particular region rather than outside cultural or aesthetic influence.

Many of Cranbury’s early buildings, dating from the mid 1700’s to the mid 1800’s, are vernacular structures. These buildings are defined by their form, plan and construction. Typically, the

houses are 1-1/2 or 2 story dwellings of modest scale with gable roofs and clapboard siding. Several plan types are identified. The so-called English cottage is a 1-1/2 story one-room-deep dwelling with a one room or two room plan, and an interior gable end chimney; the original cottage was expanded with side and rear wings. The I-house is a 2-story dwelling, one room deep and two or more rooms wide, with internal gable end chimneys. Some I-houses have a center-hall or side-hall plan. In the early 1800’s, it was not uncommon to see I-houses with Greek Revival and Italianate millwork details.

In addition to their plan and form, these houses are identified by their hand-hewn heavy timber frames with mortise and tenon (“pegged”) joinery. Many have interesting, sometimes puzzling, accruals of additions and modifications. Later wings, porch additions, and dormers are common. Some of these houses may include some stylistic detail, such as classical columns supporting a porch, or knee wall windows below the eaves.



VILLAGE VERNACULAR



SHOPS AND STORES

The small shop and store have been fixtures on Cranbury's Main Street since its early years, but the buildings themselves have evolved over time and many have been replaced. Two types of small commercial buildings are still found: the free-standing retail store or shop, and the residence with first floor shop. The freestanding retail store, typical of rural towns across the country, is one or two stories, sheathed with wood siding (or less commonly, brick), and often has a front porch.



Facing the street, the gable end may be exposed or concealed by a false front. Simple ornamental details may include turned porch supports and a cornice at the eaves. As a successor to the harness and wheelwright shops that serviced horse-drawn vehicles, one or two story concrete block and brick repair garages were built on Cranbury's thoroughfares in the early 20th century to serve the new clientele of automobile drivers.

Cranbury also has a number of stores or shops located within residential structures. The tradition of the home-industry workshop is a historical component of rural villages such as Cranbury. Some examples appear to have been built as a combination home and shop, such as the Rue Bootmaker Home and Shop on the corner of Main and Station Road. Other residential buildings were converted to commercial uses, resulting in a blending of architecture, with 19th century houses peering above later storefronts.

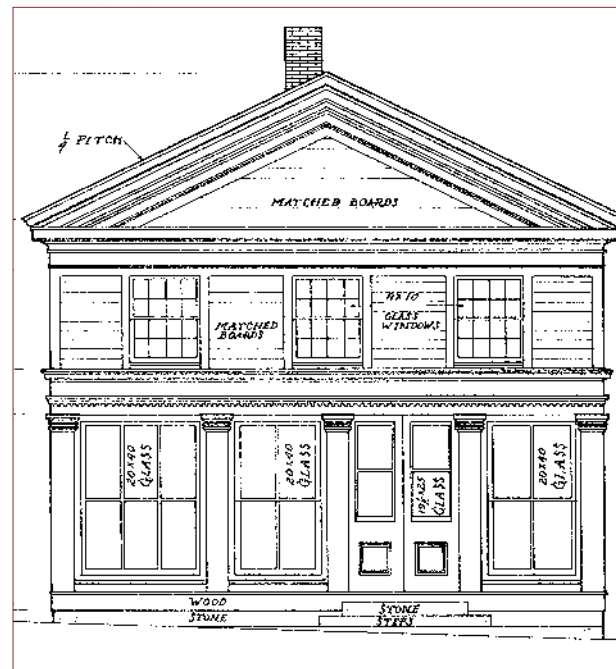

FEDERAL

In America, the term “Federal” is associated with the neoclassical buildings of the 1785-1830 period, echoing the style popularized in England by the architect Robert Adam. The Federal Style house is typically built on a two-story center-hall plan or side-hall plan, but also occurs on I-house plans (see Village Vernacular, above) with Federal detailing on doors and interior woodwork. Windows and doors are arranged in symmetrical rows. On local examples the most prominent identifying feature is the elliptical or semi-circular fan-light over the front door. Elliptical and oval shapes also appear in gable windows and on architectural trim, along with motifs such as urns, garlands and festoons.

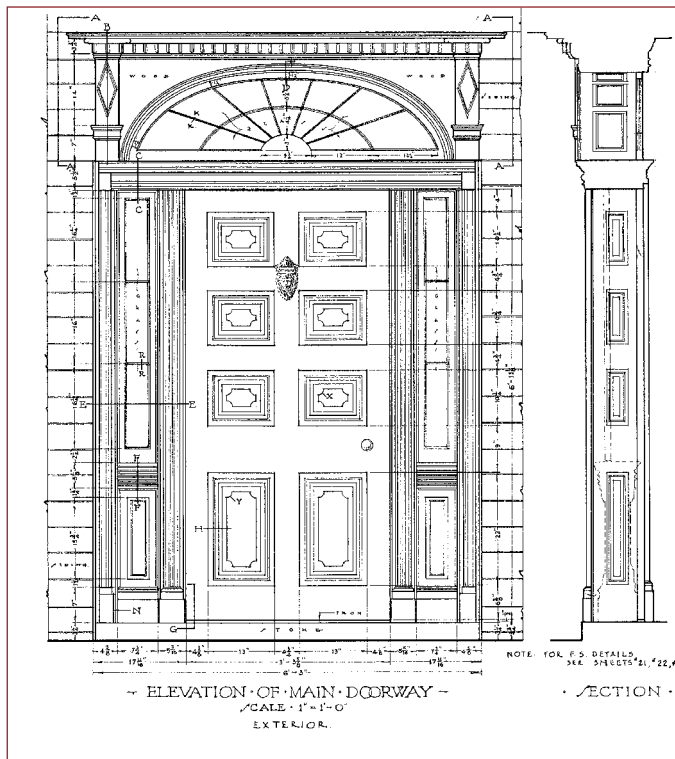

GREEK REVIVAL

The Greek Revival style was the most prevalent style for both houses and public buildings in America between 1830 and 1860, rising out of the new republic's nationalistic spirit and popular fashion for all things related to classical antiquity.

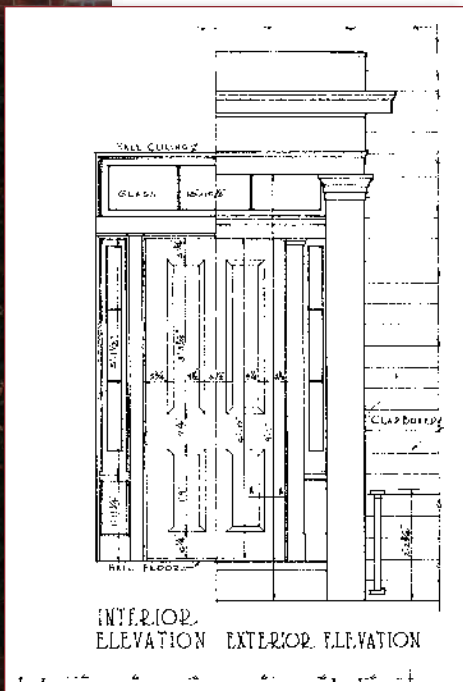

Assisted by builders' guides that illustrated facades and details, such as Minard Lafever's *The Modern Builder's Guide* published in 1833, local carpenters constructed low-pitched gable or hip roofed dwellings with classical ornament based on the Greek and Roman orders. Columns, capitals, friezes, and moldings were adapted freely from classical precedent, and building facades often emulated the form of a Greek temple, with a pedimented front-facing gable and a columned portico. Returns at the eaves, bold cornices, 6/6 double-hung sash windows, attic windows in the frieze below the eaves, and an entrance framed with pilasters and sidelights are other identifying features.

In Cranbury, as in many other New Jersey towns, Greek Revival detailing was often applied onto older traditional house forms. A columned porch or a classical doorframe may be all that signifies Greek Revival.



GREEK REVIVAL



GOTHIC REVIVAL

A number of influential early 19th century building books introduced emerging styles and designs to the American public. Andrew Jackson Downing's publications, beginning with *Cottage Residences* in 1842, sparked widespread interest in picturesque "Gothic cottages" and "Italian villas" in rural and suburban settings.

The Gothic Revival style was popular between 1830 and 1870 for houses but lasted throughout the 19th century for churches. Often built as one-and-a-half story cottages, Gothic Revival houses typically have steeply pitched roofs with cross gables, pointed arch windows, and jig sawn verge board along the eaves that is sometimes called "gingerbread." Vertical board and batten siding was the preferred exterior material.

While the high-style versions of the Gothic Revival did not find expression in many rural towns such as Cranbury, local carpenter-builders enlivened modest wood houses with "Gothic" details and ornament. Pointed arches and decorative carving at the eaves replaced rectangular openings and classical trim.

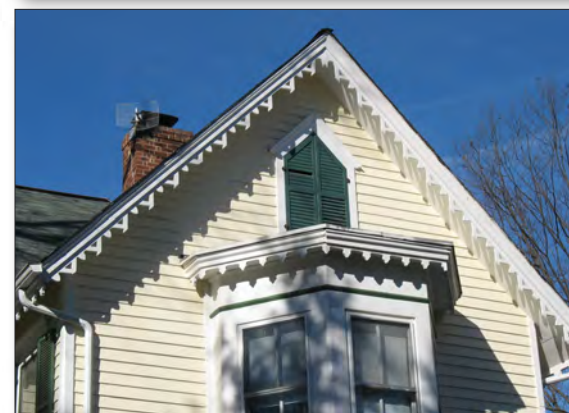
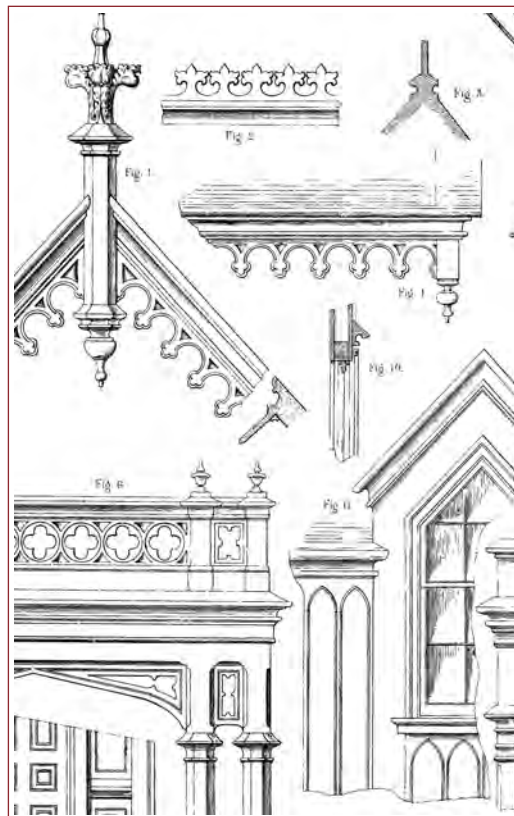

VICTORIAN VERNACULAR



In keeping with local vernacular building tradition and rural village roots, some of Cranbury's late 19th century houses and shops were constructed on traditional building forms with Victorian detailing, simplified versions of the building fashions generally referred to as "Victorian."

Commonly two stories in height, these buildings may have front-gabled roofs, side-gabled roofs or a gabled roof L-plan. The applied and less elaborate detailing may be inspired by Italianate, Queen Anne or Gothic wood millwork, sometimes in combination, and is primarily seen on porches, rooflines, doors and windows.



ITALIANATE

Italianate is a broad term for a mid 19th century style inspired by the villas and palazzos of Italy, and popularized by pattern books. Built in Cranbury from the 1850's through the 1880's, Italianate houses have a low-pitched hip or gable roof with wide overhanging eaves and sometimes a cupola or tower. Other identifying features include heavy decorative brackets under the roof eaves and over windows and doors; tall narrow windows, often paired and frequently arched; and heavy paneled doors, often paired with elaborate frames. The commercial counterpart is chiefly a storefront design characterized by ornate bracketed cornices and a variety of arched window treatments.

Other identifying features include heavy decorative brackets under the roof eaves and over windows and doors; tall narrow windows, often paired and frequently arched; and heavy paneled doors, often paired with elaborate frames. The commercial counterpart is chiefly a storefront design characterized by ornate bracketed cornices and a variety of arched window treatments.

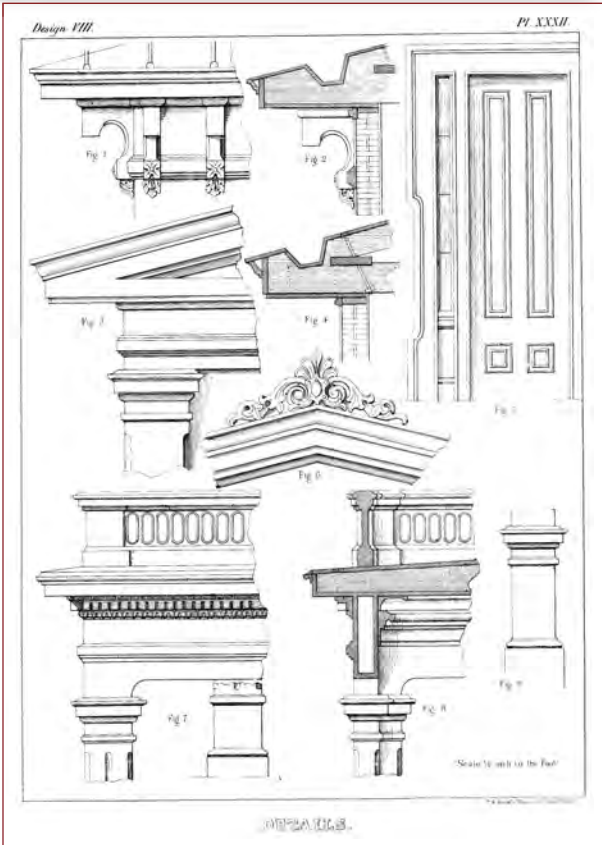

ITALIANATE



QUEEN ANNE

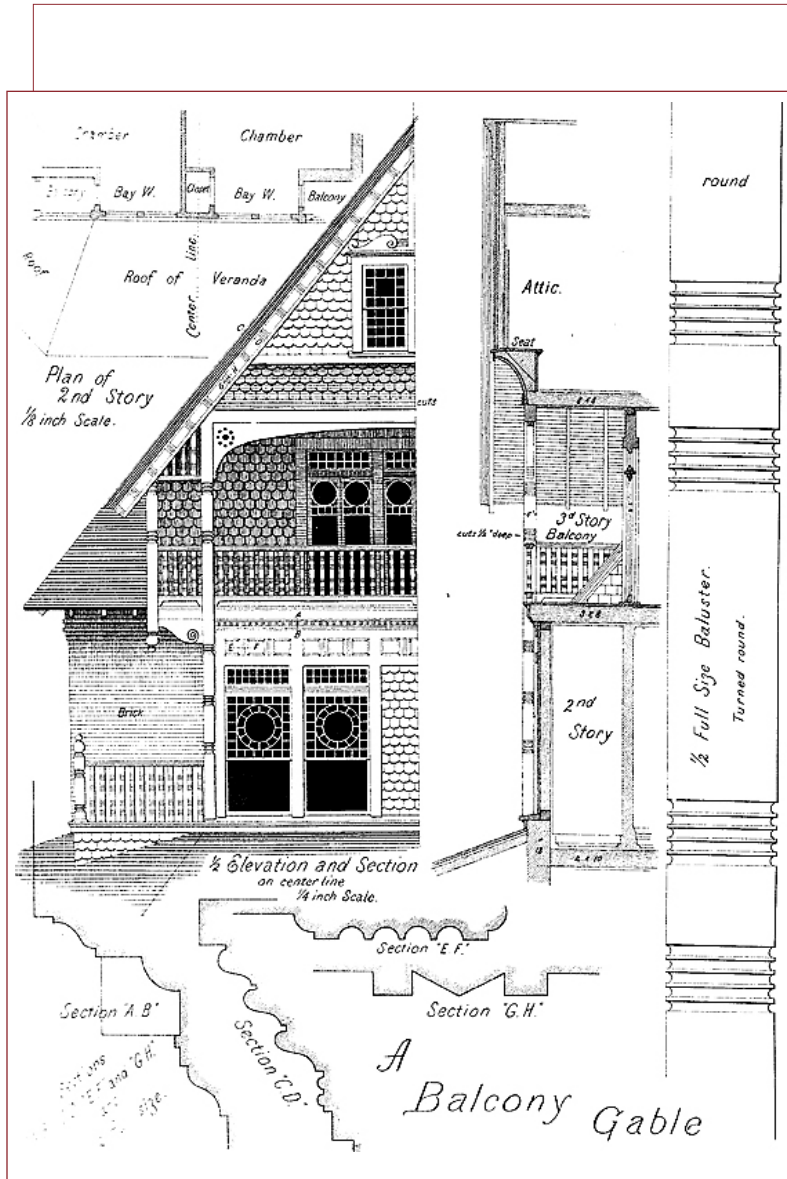

Plate 68



The 1876 Philadelphia Centennial Exposition helped to create a taste in America for rural medieval English houses, on which the early Queen Anne style was based. From the 1880s and until about 1910, the Queen Anne style brought exuberant combinations of materials, shapes and textures to American residential building. Brick, stone, patterned shingles and clapboard are often combined on exterior walls, which may be decorated with elaborate millwork and art glass. Towers, turrets, balconies and projecting bays further characterize this style. The later phase of Queen Anne, known as “Free Classic,” acquired a less medieval appearance and emphasized classical details.

COLONIAL REVIVAL

The term “Colonial Revival” refers to the national rebirth of interest in the colonial building traditions of the original thirteen colonies. Rising to prominence in the 1890’s, the Colonial Revival style dominated residential construction during the first half of the 20th century. Most Colonial Revival structures were free interpretations inspired by colonial precedents, while others were carefully researched copies of original 17th and 18th century buildings with historically correct proportions and details. Typical features include colonial-

derived materials and design elements, but larger in scale than colonial buildings. Large double-hung sash windows, accentuated front doors with sidelights, and ample porches are common.

The Cape Cod house is a sub-type of the Colonial Revival style. Built widely in America from the 1920’s through the 1940’s, Cape Cod houses were based loosely on the early wooden houses of coastal Massachusetts. These affordable houses offered the charm and popular appeal of a colonial cottage. The Cape Cod house form is 1-1/2 stories with a side gable roof, symmetrical façade and central doorway. Clapboard or shingled siding, six over six double-hung sash windows, dormers, and small trellised porches are common features.



PERIOD REVIVAL

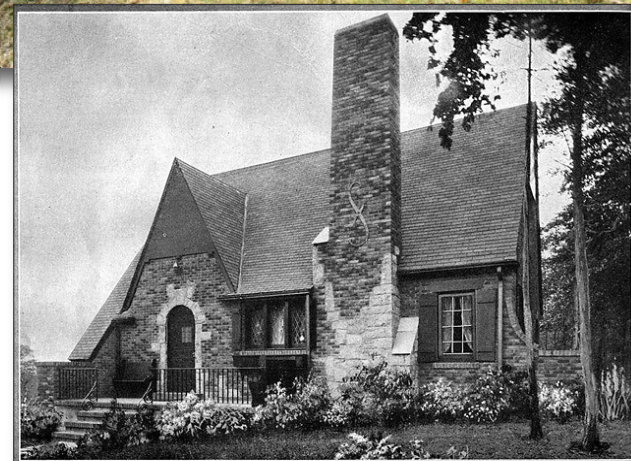

The HILLSBORO
No. 3308—Already Cut and Fitted
Monthly Payments as Low as \$55 to \$70

Period Revival houses, popular between 1900 and 1940, were patterned after such diverse historical sources as English Tudor manor houses, rural English cottages, Mediterranean villas, provincial French dwellings, and Spanish colonial missions. Quotations from the historical past were employed freely to produce houses that were modern in plan and composition. Most of Cranbury's Period Revival houses are loosely based on English Tudor or medieval English building traditions. They are characterized by high-pitched gable roofs, elaborate chimneys, stuccoed and brick walls with decorative half-timbering, and a variety of window types including leaded-glass casements.

CRAFTSMAN

Craftsman houses, which include both bungalows and two story examples, are linked to the American Arts and Crafts movement of the 1900-1930 period. Craftsman houses exhibit the use of natural materials, rustic simplicity, and craftsmanship as promoted by the craftsman movement. These houses are characterized by their low-pitched roofs with wide overhanging eaves, exposed roof rafters, truss work in the gables, and tapered porch posts.



FOURSQUARE

The Foursquare was a widely popular post-Victorian house form. Often sold through mail order companies, the Foursquare derived its name from an interior plan of four nearly equal-sized rooms on each floor. The Foursquare house is identified by its cubical shape, often with a pyramidal roof. Large dormers, a full front porch, and a raised basement with steps to the first floor are common. Many of Cranbury's Foursquares have Colonial Revival details.



BARN, CARRIAGE HOUSES AND GARAGES



Historically, the residents of Cranbury village kept carriage and wagon horses, perhaps a cow or two, and chickens. A variety of barns, stables, sheds and domestic outbuildings such as privies and well houses shared the backyard space with small-scale agriculture, fruit-bearing trees, and vegetable and ornamental gardens. By the late 19th century, carriage houses were constructed to match the styles of new Victorian houses in town, combining an up-to-date plan for housing horses and carriages with new architectural fashions. A few short decades later, the automobile introduced the garage into the village landscape, and older carriage houses were often adapted to new uses as automobile garages. A variety of 19th and early 20th century outbuildings remain in Cranbury. These have assumed greater significance as the numbers of out-buildings in the village have declined.



DESIGN GUIDELINES FOR REPAIRS, ADDITIONS AND NEW CONSTRUCTION

The Design Guidelines are the criteria by which the Historic Preservation Commission will review applications and determine the appropriateness of proposed work in the Cranbury Village Historic District.

The Design Guidelines cover repair and alteration of existing buildings, and construction of new buildings in the Cranbury Village Historic District, the Historic Buffer Area, and historic sites. Alteration of existing buildings or construction of new buildings can either strengthen or detract from the historic character of individual structures and the entire district. Seemingly small decisions about design have the potential, over time, to visibly change the character of a place for better or worse.

The guidelines seek to protect and preserve the distinguishing characteristics of Cranbury's historic village, while allowing expressions of change and adaptation. Any building design should be carefully related to its site, its neighbors and its heritage.

Design should strive to maintain significant existing features, while encouraging and integrating compatible new features. These should reinforce and build upon the best of earlier building traditions, but not necessarily duplicate them. Imitative architecture is not the objective of these design guidelines. Stylistic variety can enrich and add interest to the appearance of the community. Siting, scale, proportion, massing and materials are more important than recreating a particular historical style in achieving an appropriate design within the historic village.

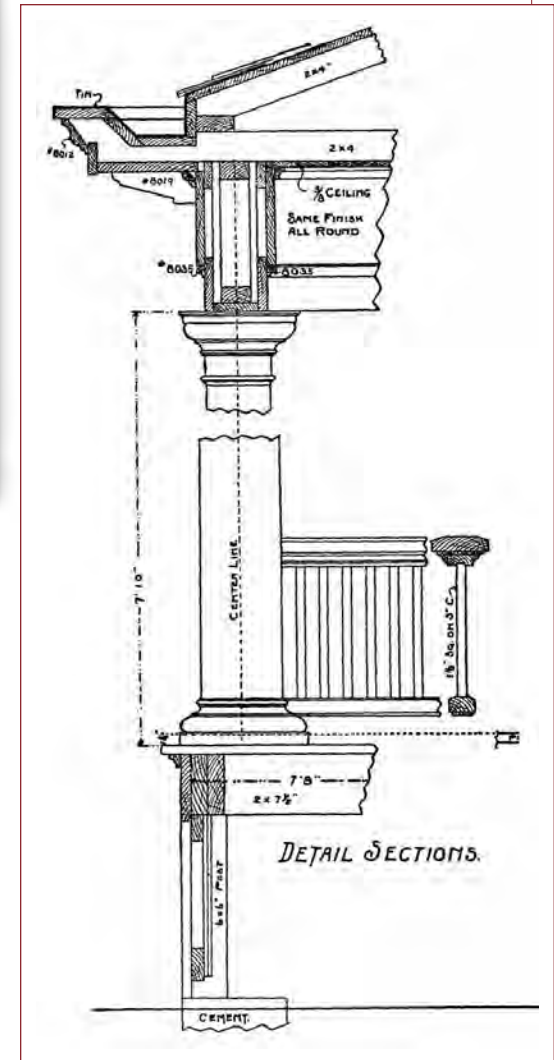
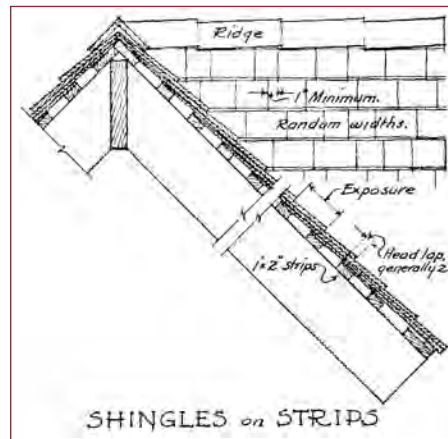

DESIGN GUIDELINES FOR REPAIRS, ADDITIONS AND NEW CONSTRUCTION

Principles of Preservation: The Secretary of the Interior's Standards

The Cranbury Historic Preservation Commission is guided by The Secretary of the Interior's Standards for the Treatment of Historic Properties, with Guidelines for Preservation, Rehabilitation, Restoration and Reconstruction. As rehabilitation is the most common treatment approach, the Standards for Rehabilitation are cited below. The Standards are intended to promote responsible preservation practices that help protect our Nation's cultural resources, and are used nationwide for planning and reviewing work on historic properties. The Standards do not offer specific answers for each site or building, but they do provide a philosophical framework for treatment of historic properties, and for the Design Guidelines herein.

- 1. A property shall be used for its historic purpose or be placed in a new use that requires minimal change to the defining characteristics of the building and its site and environment.*
- 2. The historic character of a property will be retained and preserved. The removal of historic materials or alteration of features and spaces that characterize a property shall be avoided.*
- 3. Each property shall be recognized as a physical record of its time, place, and use. Changes that create a false sense of historical development, such as adding conjectural elements features or architectural elements from other buildings, shall not be undertaken.*
- 4. Most properties change over time; those changes that have acquired historic significance in their own right shall be retained and preserved.*
- 5. Distinctive features, finishes, and construction techniques or examples of craftsmanship that characterize a property shall be preserved.*
- 6. Deteriorated historic features shall be repaired rather than replaced. Where the severity of deterioration requires replacement of a distinctive feature, the new feature will match the old in design, color, texture, and, where possible, materials. Replacement of missing features shall be substantiated by documentary, physical, or pictorial evidence.*
- 7. Chemical or physical treatments, such as sandblasting, that cause damage to historic materials shall not be used. The surface cleaning of structures, if appropriate, shall be undertaken using the gentlest means possible.*
- 8. Significant archeological resources affected by a project shall be protected and preserved. If such resources must be disturbed, mitigation measures shall be undertaken.*
- 9. New additions, exterior alterations, or related new construction shall not destroy historic materials that characterize the property. The new work shall be differentiated from the old and shall be compatible with the massing, size, scale, and architectural features to protect the integrity of the property and its environment.*
- 10. New additions and adjacent or related new construction shall be undertaken in such a manner that if removed in the future, the essential form and integrity of the historic property and its environment would be unimpaired.*

SITE AND STREETScape

The relationship of buildings to each other, setbacks, spaces between buildings, fences, views, driveways, walkways, and other landscape features create the character of an individual parcel of land, streetscape, neighborhood, and village. The historic features of a particular site and its surrounding environment should be an integral part of any project involving additions or new construction.

The first settlers of Cranbury generally built their homes facing south to capture the warmth of the sun. As the settlement grew into a village, houses and stores were oriented toward the street. Within each of the areas of town built during Cranbury's major period of development from the mid 19th to early 20th centuries, there developed a strong consistency of setback, alignment, façade orientation to the street, and other site characteristics.

It is important to recognize that some of Cranbury's historic buildings are sited on lots that differ from the predominant building pattern. The special character of these properties – the size of the lot, the uninterrupted view from the street, the placement of the house and accessory structures, driveways, and other individual site features – should be preserved. Subdivision of these properties should be avoided as it will inevitably destroy the site characteristics that contribute to the significance of these early houses. Likewise, relocation of these houses to accommodate



Landscape – Topography, trees, shrubbery, hedges and other landscape plantings are of primary importance to the visual image of the village, and to its historic character as well. Modern landscape schemes and inappropriate plant materials can detract from even the most carefully restored older building. While the Historic Preservation Commission does not regulate residential plantings, it recommends that older trees and plant material be considered before they are removed. New plantings that complement the building architecture are also recommended, in order to create harmony between structures and their natural landscapes.

new development is strongly discouraged. Left in place, historic buildings – even the modest houses of Cranbury's early settlers – help to link past and present, a tangible reminder of the community's growth and long history.

Building Site – Additions and new construction shall be compatible with the pattern of site utilization of the individual property and the buildings to which it is visually related. Each proposal must be evaluated in relation to its particular site characteristics. Compatibility of setback, orientation, and rhythm of spacing

between buildings is of foremost concern. Principal elevations of buildings characteristically face the street with a strong sense of entry. New buildings having a courtyard arrangement, or otherwise turning their backs to the street, are not permitted.

Garages and Accessory Structures – The siting of a garage or other accessory structures should not be unnecessarily prominent. The garage must be positioned farther back on the lot than the main wall of the house; placement of the garage to the rear of the lot is preferred in areas where this is the historic pattern. Garages must be coordinated with the style of the house, and compatible in size with major historic structures on the property. Garages shall be detached from the historic house; attached garages located within new rear additions may be considered if the garage entry is not visible from public view.

SITE AND STREETSCAPE

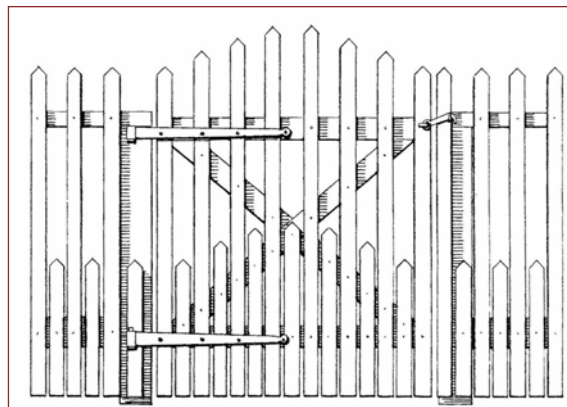
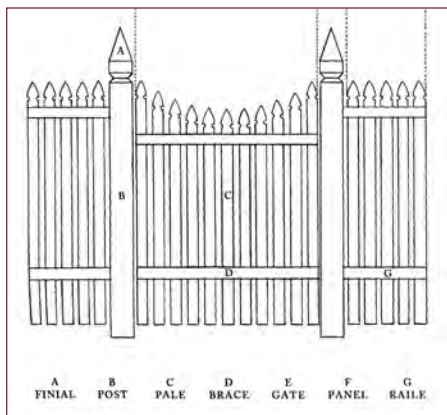

Fences – Historic fences vary with the age and style of buildings. They define the boundary of a yard or garden, and can be a prominent ornamental element. Historic fences in Cranbury are most often wooden – such as picket fences – but may also include wrought or cast iron fences. High berms and modern fence types such as chain link, split rail or contemporary metal railings are not appropriate. These can be used only when shielded from the public view.

Walkways – Bluestone, slate, and brick side-walks and walkways are still prominent in Cranbury. Retain historic walkway materials, and re-set when necessary. When replacing concrete with concrete, match texture and color. Bluestone, slate, brick, and concrete are all appropriate materials for new walkways in the public view; decorative concrete pavers that simulate brick and stone are not appropriate new materials.

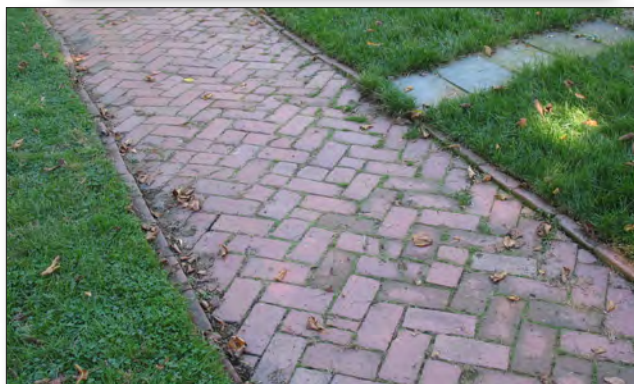

Home Grounds and the Village Landscape

Although older homes may closely resemble their earlier appearance, few yards, or “home grounds” as they were often called, are still found in the fashion in which they were originally landscaped. Ornamental landscaping became a popular pastime beginning in the mid-19th century. Home owners were assisted by a widely available collection of gardening and landscaping books and periodicals, including those by Andrew Jackson Downing and R. Morris Copeland. These disseminated information on topics such as planting design, horticultural specimens, ornamental fences, and grafting techniques.

Detecting remnants of 19th century landscape design can be difficult. Maps and old photographs are a good source of information about the former appearance of home grounds for the interested contemporary homeowner. Today, evidence of earlier landscape design can still be found in details such as paths and walks, the occasional stone retaining wall or post, fences, garden structures such as arbors and gazebos, and the species and placement of older trees and plantings.

ADDITIONS AND NEW CONSTRUCTION

Additions to existing buildings and new construction within the historic district can enhance the existing village character, and can add depth and contribute interest to the district.

The success of new construction within the historic district does not rely on duplication of existing building forms, features and details; these provide a vocabulary, but not necessarily a copybook, for new buildings. Successful new construction does depend, however, on an understanding of the village architectural character – the patterns of siting (setback, orientation, spacing) as well as building size, massing, proportion, directional expression, materials and design features.

Site new construction to be compatible with site-specific features of the individual property and surrounding buildings. Conform to the design guidelines in Site and Streetscape.

How well an addition or new building fits in with its surroundings is determined by a number of design factors in addition to site planning. Size, massing, proportion, and directional expression all are essential considerations when designing an addition to a historic building or a new building in a historic district. Other important design elements – roofs, surface materials, doors and windows – are covered in subsequent sections of the Design Guidelines.

Size – Size includes the height, width and overall bulk of a building. On a street of generally aligned facades, new buildings should be within the range of building heights and widths along the block. The overall bulk of additions and new construction must not overwhelm the original building size or the places to which it is visually related.

Massing – Similarly, the massing (form and shape) of additions and new construction should harmonize with the original building and the buildings to which it is related, yet it should be discernible from the original building. Additive massing – the attachment of smaller volumes of related shape – is recommended. Single boxlike forms should be broken up into smaller varied

masses with articulated facades as are common on Cranbury's older buildings. To preserve the historic character of a building's mass, additions should be extended to the side and rear; the integrity of the front façade must be maintained.

Proportion – The proportions of a building façade are important because the front is the most visible part of the building and is viewed in relation to adjacent buildings. The proportion – relationship of height to width – of a building's primary façade must be visually compatible to the buildings and places to which it is visually related. Proportion also pertains to window and door openings. The relationship of width and height of windows and doors on a façade must be carefully considered.

Directional Expression – The shape of a structure, placement of openings and other architectural details provide an overall directional expression to a building façade. Buildings may have a vertical, horizontal or non-directional emphasis. Relate the vertical, horizontal or non-directional façade character of new buildings to the predominant directional expression of nearby buildings. If, for example, a proposed new building appears too horizontal in relation to more vertical adjacent structures, consider dividing the façade into smaller masses with vertical elements in order to conform to the streetscape.

Size, Massing and Placement of Additions

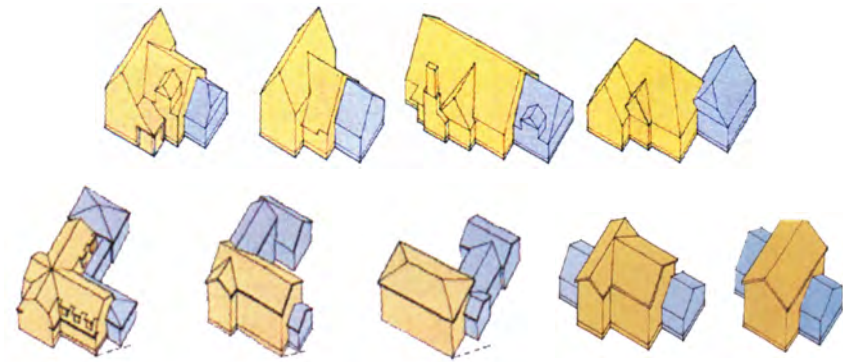

EXTERIOR MATERIALS



The wall surface is the skin of a building, a barrier to the weather and an expression of age, style and craftsmanship. The vast majority of buildings in the Cranbury Village Historic District are of wood frame construction, sided with clapboard or shingles. Depending on the particular architectural style, wall surfaces also include patterned shingles, board and batten siding, applied timber work, stucco, brick, and natural stone.

Original surface materials shall be retained and repaired on existing historic buildings. Recommended repair techniques for wood siding and masonry walls are widely available in publications on home renovation, and on the internet. When removing deteriorated paint from wood siding, avoid destructive removal methods such as sandblasting. Recommended methods include hand scraping, hand sanding, electric hot air guns, and certain chemical strippers. Historically painted wood siding must not be stripped or stained to create a “natural” effect.



Maintain the original color and texture of masonry walls. Stucco or paint must not be removed from historically painted or stuccoed masonry walls. Likewise, paint or stucco must not be applied to historically unpainted or unstuccoed masonry walls.

Clean masonry or mortar only when necessary to halt deterioration or to remove heavy soiling, using the gentlest method possible, such

as low pressure brushes. Sandblasting, caustic solutions, and high pressure water blasting must not be used. These methods erode the surface of brick and stone, and accelerate deterioration.

Repoint masonry walls when there is evidence of disintegrating mortar, cracks in mortar joints, loose bricks, or moisture retention in the walls. The new mortar must duplicate the old mortar in composition, bonding strength, profile, color and texture.

If a masonry wall surface is too damaged to repair, replace it with material of like construction, matching as near as possible in size, shape, texture and color. Materials such as artificial stone (“Permastone”) and artificial brick veneer (“brickface”) are not permitted for re-surfacing historic masonry buildings.

EXTERIOR MATERIALS

Existing wood siding on historic buildings shall be retained and repaired. If wood siding is too damaged to repair, replace it with wood material of like construction, matching as near as possible in size, shape, profile, and texture.

The wall surfaces of new additions and new buildings in the historic district shall be sided with the materials of historic wall surfaces found on adjacent buildings and in the historic district. Cement board siding (such as HardiPlank) is, however, an acceptable alternative to the use of wood siding on new buildings.

Synthetic siding will be approved to resurface wood-sided historic structures only if the areas to be sided are not visible from a public street. Likewise, synthetic siding will be permitted on new additions to historic buildings that are not visible from a public street.

In cases where a non-historic artificial siding has been previously applied to a building, restoration of the historic siding material is preferred. Synthetic siding is permitted only if all the wood architectural trim is restored. Cement board siding (such as HardiPlank) is preferred over vinyl or aluminum.

In any of the above mentioned cases, synthetic siding will be approved only if the following conditions are met: (1) the substitute siding will not endanger the physical condition and structural life of the building; (2) the substitute siding can be installed without irreversibly damaging or obscuring any of the architectural features and trim of the building; and (3) the substitute material can match the historic material in size, profile and finish.

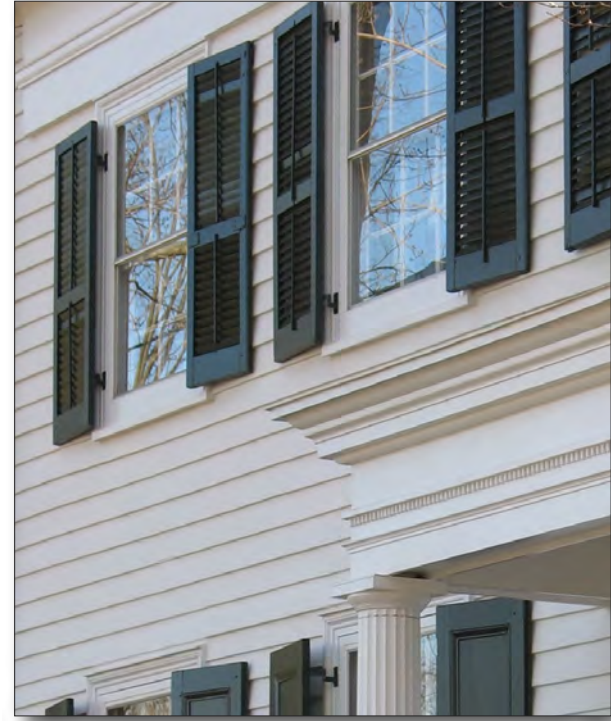

EXTERIOR MATERIALS

Problems of Aluminum and Vinyl Siding

Synthetic siding hides a building's design details and ornaments. In fact, if your old house has synthetic siding now, the details may have been removed when the siding was installed. Synthetic siding can even ruin the proportions of an early 20th century frame house. Window casings, drip caps, moldings, and door trim are often obstructed, destroying the three-dimensional appearance.

Many sidings act as exterior vapor barriers, trapping excess water vapor, which condenses and damages the wood. Rot and insect attack may proceed unnoticed. If installed incorrectly or damaged, runoff water may enter behind the siding and be trapped. Also, artificial sidings offer no structural support, so that if continued deterioration leads to failure, the siding will buckle and separate from the building.

In addition to all these crimes, aluminum siding tends to dent and scratch, and its color coating can peel and fade. Solid vinyl siding punctures and tears; it is sunlight-sensitive, becoming brittle and faded if not treated with an ultra-violet inhibitor. Since the industry frequently changes its product lines, replacing a section of damaged siding may be impossible. Successfully painting siding is also difficult.

If you're sold on siding for its fire safety and insulation qualities, think again. Aluminum siding may make it difficult to

get to a fire's source, while vinyl siding melts, curls and sags. The Federal Trade Commission reports that synthetic sidings have little or no insulation value.

Aesthetic value, of course, is not quantifiable. Yet it may be an economic consideration because a property will retain greater value with properly maintained original materials. While siding may enhance the short-term resale value, authentic materials and style increasingly command a premium. Real-estate appraisers and potential buyers may also wonder what problems the siding may be hiding.

– *The Old House Journal Guide to Restoration* (Dutton, 1992).

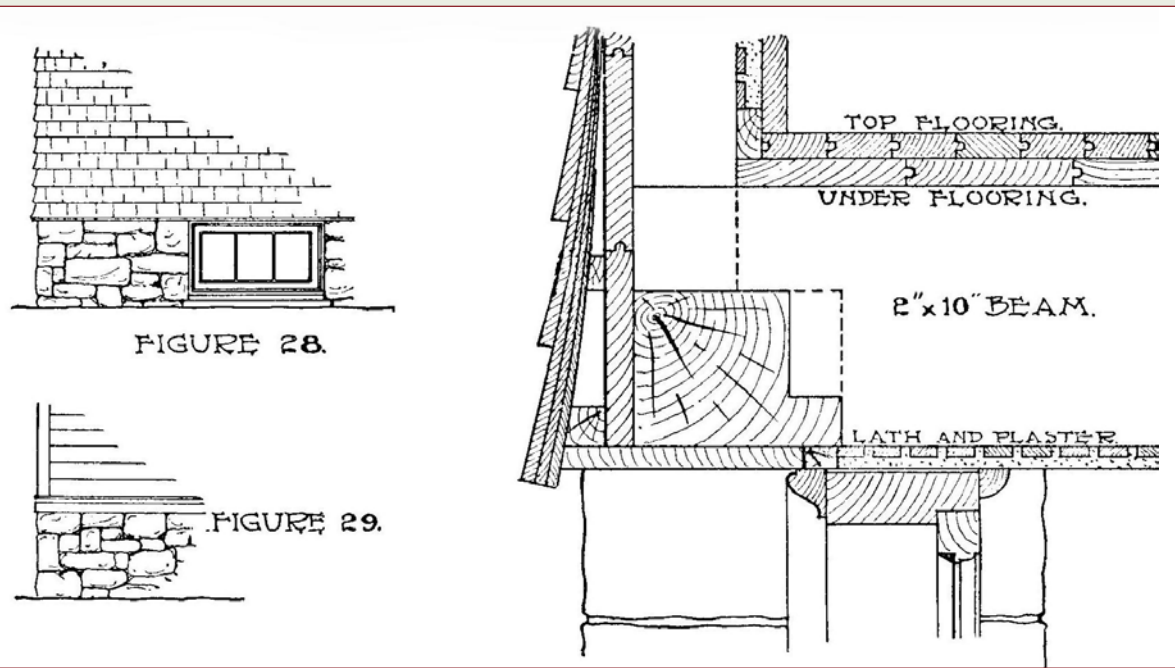

ROOFS



The roof is an essential cover for any building, important for maintaining the soundness of the entire structure. Roofs create the shape and appearance of Cranbury village's skyline. The shape of the roof, the size, color and pattern of roofing materials, and features such as chimneys, dormers, eaves and gutters are all important design elements to consider in repairs, additions and new construction.

Historic roofing materials include wood shingles, clay tile, slate, metal (sheet metal, tin plate, copper, lead and zinc), and in the 20th century, built-up or roll roofing, concrete and asphalt shingles. On 19th century buildings, steeply sloping complex roofs with ornate decoration are a key part of the stylistic composition.

Retain the original shape, pitch, configuration, and material of the roof. If patching a roof, match existing materials. When replacement of historic roofing is necessary because it is too deteriorated to repair, use of compatible substitute materials may be considered. Asphalt and fiberglass shingles, for example, may be used to replace slate if the style, shape and color are chosen carefully to resemble historic roofing materials.

Preserve the decorative and functional features of the roof, such as eaves, cornices, chimneys, dormers, cupolas, gutters and flashing. If a feature is too deteriorated to repair, the replacement shall be of like construction, matching as nearly as possible in material, size, shape, texture and color.

Of particular concern in roofing projects are the eaves and gutters. Many older buildings have built-in gutters that are integrated into the design of the eaves and cornice; these are an important part of the historic roof and must be maintained. External gutters, which are hung at the edge of the roof, are not allowed on structures with built-in gutters. Where hung gutters are appropriate,

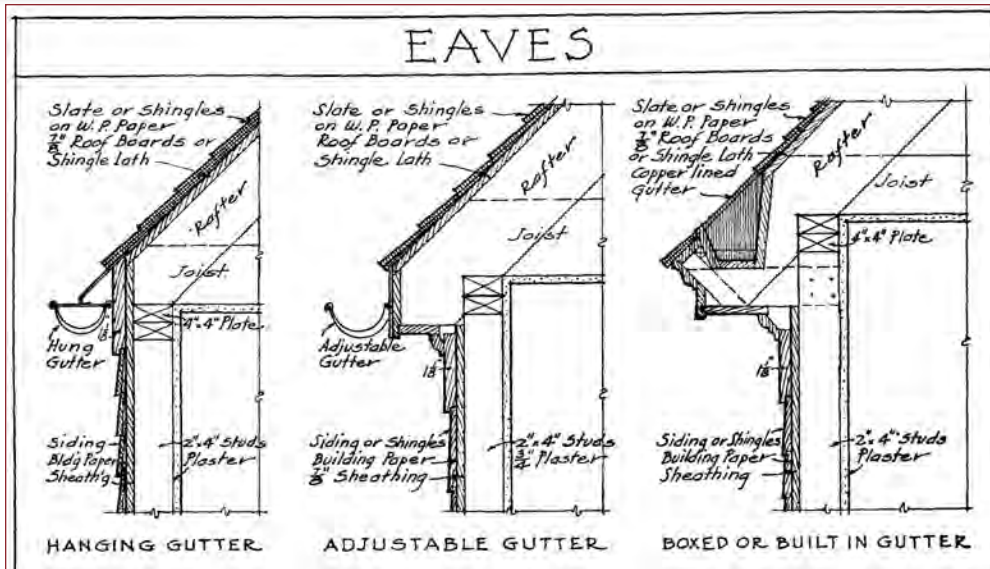

ROOFS

they must be installed so that they do not interfere with the architectural detail. Half-round gutters are preferred.

Roof additions on existing buildings must not damage or obscure the historic character of the roof. The roof pitch, plane, eave overhang and detailing of an addition must be compatible with the main roof. Locate new chimneys, vent stacks, dormers, skylights, mechanical and service equipment, and solar collectors so that they are inconspicuous from the public street. Construct new chimneys of masonry, either brick or parged concrete, with a traditional ground-level base, not cantilevered over the foundation of the house.

New roof dormers must be carefully designed and placed to be in scale, proportion and balance with the roof and the building. A dormer should complement, not destroy, the roof plane in which it is placed. For this reason, dormers are not to be placed on the front elevation, and large dormers that extend the entire length of the roof are not permitted.

Roof designs for new construction must harmonize with the shape, rhythm and design features of roofs along the street. Where an area shows a predominant roof type, new roofs should be guided by the existing character.



WINDOWS

The size, arrangement, materials, design and craftsmanship of windows are all important to the historic character of a building, and each building has distinguishable windows that reflect its historic period and style. On most buildings, windows comprise a significant percentage of the overall wall area. For these reasons historic windows deserve special consideration. If original windows are removed and replaced with incompatible modern windows, the basic character of the building will be altered substantially.

Wooden double-hung sash windows are the predominant window type in Cranbury's older buildings. The size of the sash windows and the number of window panes vary with the age and style of the building. Wooden or steel-framed casement windows are found on later houses, as well as on commercial and industrial structures.

The number, size, shape and locations of existing windows must be retained. Do not "block in" windows to reduce the size of the opening or to fit stock sizes. New window openings must not be added to the front elevation.

Preserve original or early windows wherever possible. Retain and repair window frames, sash, decorative glass panes, sills,

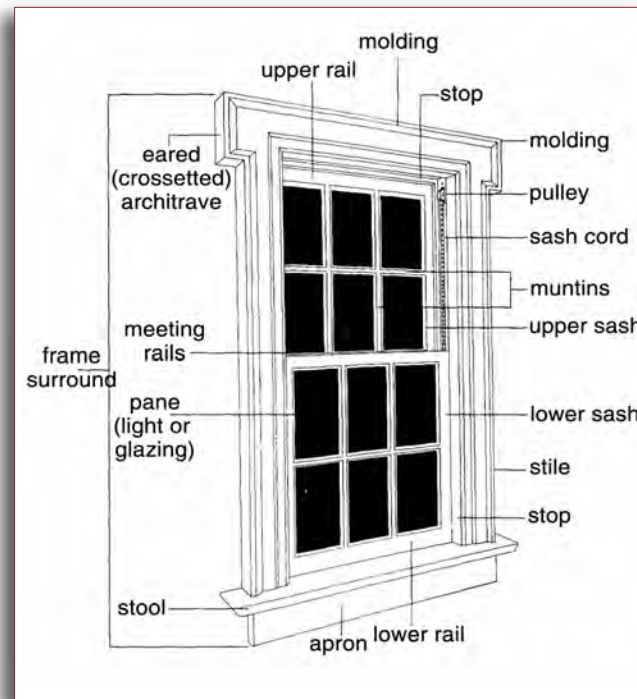

heads, hoodmolds, moldings, and exterior shutters and blinds. New or replacement windows on historic buildings must be appropriate to the period and style of the building, duplicating the material and design of the older feature. Replacement sash of wooden windows must be wooden. True divided light sash or simulated divided lights are acceptable, but snap-in muntins are not. Replacement sills and window frames should be constructed to true historical dimensions to match existing. If duplication of the original window is not technically or economically feasible (such as replacement of an elaborate stained glass window), a simplified version of the original may be acceptable as long as it has the same size and proportion.

Some later windows may have acquired significance in their own right (such as Colonial Revival changes on older houses) and should be respected because they are evidence of the building's history.



WINDOWS



Avoid using modern windows that are inappropriate to the historic period of the house if they are visible from public view. Modern window types which are inappropriate include large picture windows, sliding glass doors, casements, bay and bow windows unless they are original to the building.

Replacement shutters on windows must be wooden, and sized to cover the entire window when closed. Fasten shutters to the window frame, not to the siding. Preserve and repair your early shutter hardware; hinges, holdbacks, and latches are valuable and must be retained. Window features such as plastic and metal awnings, or fake non-operable synthetic shutters and blinds, are not appropriate.

Wood-framed storm windows are preferable; if metal storm windows are used, they should be anodized or painted to blend with the trim.

On a new addition to an old building, or in new construction, windows must harmonize with the material, scale, proportion, placement and rhythm of windows on buildings to which they are visually related.

The use of historic window types is not required, but is encouraged, on additions and new construction.



Wood Window Replacement

All too often, replacement of historic wood windows is the quick-fix for reparable problems such as peeling paint, a rotten section of sash, or loose glazing. If you have original or early windows on your building, consider repair before replacement. Most wood sash windows and steel-framed windows can be repaired, insulated, weather stripped and re-fitted for about the cost of a good quality replacement window. Older windows are often needlessly replaced because of the promised insulating qualities of new windows. But weatherization

of historic wood windows – a combination of new weather stripping and exterior storm windows – is an economical alternative to replacement windows and will greatly improve the thermal performance of existing windows. In fact, an older wooden window with a high quality storm window is about 15% more energy efficient than a new double thermal paned vinyl

replacement window. In addition, the components of vinyl replacement sash have a relatively short life span compared to historic wooden windows. The vinyl and PVC materials, and plastic and neoprene sealants in these windows degrade within a much shorter time frame than wooden window components.

DOORS



Doorways are often the central focus of historic buildings, and integral to the overall design. Each building has doors that directly relate to its historic period and style. In Cranbury, doors range from traditional six-panel doors to double-leaf arched doors with ornate moldings, and can be highly decorative and characterized by fine craftsmanship. Removal and replacement of original or early doors will diminish the historic integrity of older buildings.

Retain the number, size, shape and locations of existing entrances visible from the public street. Primary entrances must not be moved, and new door openings must not be added to the primary elevation.

Maintain doors, fanlights, sidelights, pilasters, door frames, and finish hardware. All the doorway details – moldings, decorative glass, hinges and door-knobs – add substantially to the character and value of your building. Repair of historic wood doors is always preferable to replacement; patching and repairing, using epoxies and splice repairs, can be a cost effective alternative to replacement. If a door is too deteriorated to repair, use the existing door (or evidence of the building's original or early door) as a prototype for replacement. New or replacement doors on historic buildings must be appropriate to the period and style of the building, duplicating the material and design of the older feature. Salvage yards are often a good source for good old doors. If using

DOORS

the same material is not technically or economically feasible, a compatible substitute may be considered.

On a new addition to an old building, or in new construction, the use of historic door types is encouraged. Doors on a new building should be constructed of wood and must harmonize with the scale, proportion and rhythm of windows and doors of buildings to which it is visually related.

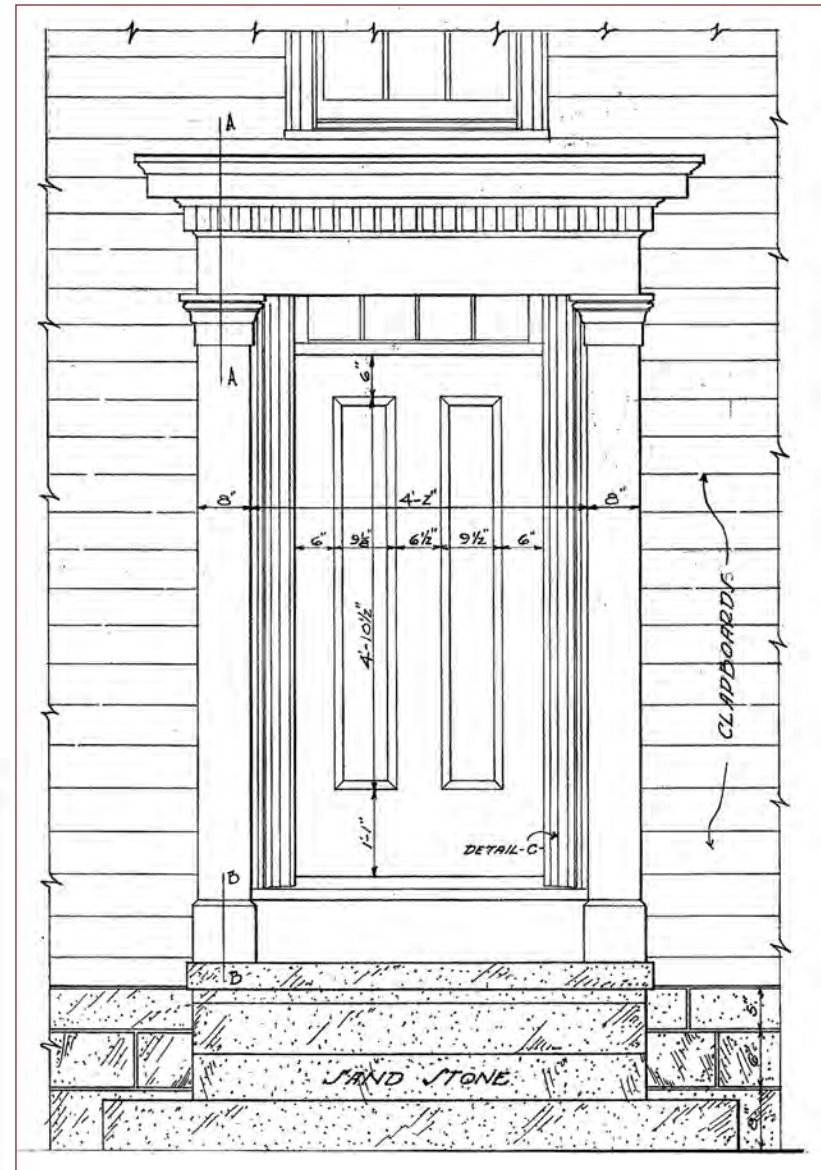

PORCHES

A photograph of Cranbury's Main Street invariably includes a front porch. Rows of projecting front porches of all sizes and kinds are a distinctive visual element in Cranbury village, and part of its overall quality of welcoming neighborliness. Roofed porches are found on many 19th and early 20th century houses, ranging from simple bracketed hoods or columned porticos over the doorway to expansive highly decorated porches that wrap around two sides of the house. Side and back porches became increasingly popular in the 20th century.

Historic porches shall not be removed. Retain original porch features – the roof and its decorative cornices, the porch columns, railings and balustrades, as well as the flooring, steps, and base all combine to create a porch's historic character. Do not remove or discard elements if they can be repaired and re-used. Dutchman repairs and epoxy consolidation are cost effective, time-tested methods for repairing damaged sections of posts or trim without replacing the whole component. Some porches are early 20th century additions on older houses, and should be respected because they are part of the building's history. Open front porches may not be enclosed with opaque walls or screened; side or back porches, however, may be screened in.

If it is necessary to replace any original porch elements, the replacement must match in material



and design. Use the original feature as a basis to remake replacements. Restoration of original features such as porch posts is always preferred to simplified replacement versions. Brick, concrete and wolmanized decking material are all unsuitable for porches with historical tongue and grove wood flooring. Extensive replacement of porch elements may be avoided by an approach that includes selective repair rather than wholesale replacement.

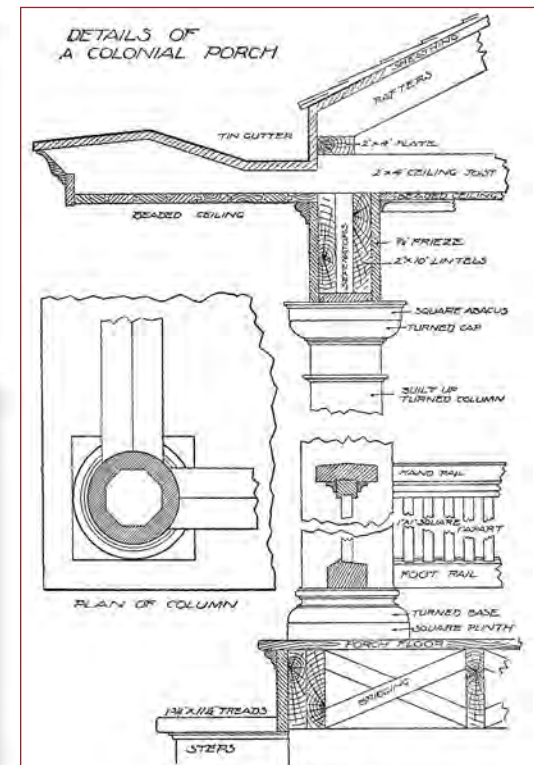

TRIM

Trim refers to the ornamental details applied to a building such as cornices, brackets, pilasters, railings, corner boards, finials, bargeboards, and window and door casings. Historic trim materials may include wood, cast iron, terra cotta, stone, tile or brick. Architectural trim elements are indicators of a building's historic period and style, and may exemplify skilled craftsmanship, which cannot be duplicated today.

Removal of an older building's historic trim diminishes its historic, and its financial, value.

Retain and repair in kind to match existing historic trim elements, rather than replace, the trim elements on your historic building.

Where it has been determined that features are too deteriorated to repair, replace trim with material that is similar in composition, size, shape, texture and color. Certain synthetic or substitute materials (such as fiberglass columns) will be considered on a case-by-case basis where they are compatible in size, proportion, style, and texture.

See also sections on Roofs, Windows and Porches for guidelines on Trim.

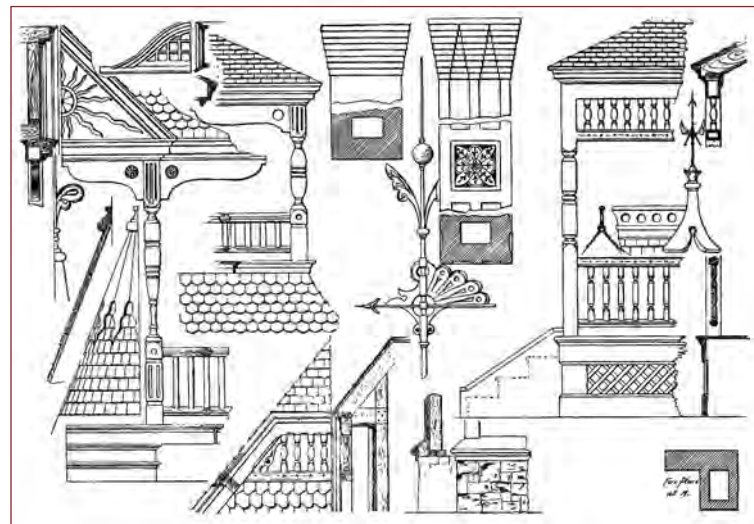
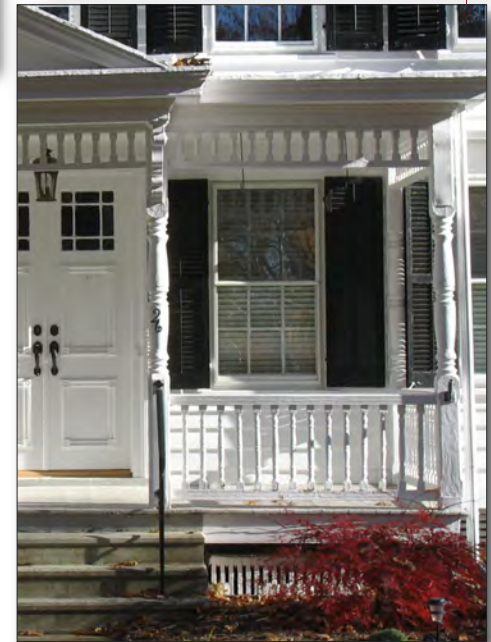

STOREFRONTS

The storefront is the most prominent architectural feature of most commercial buildings. Alterations to storefronts are common because storefronts play an important role in advertising and merchandising. These alterations, however, can completely change or destroy a commercial building's historic character. Conversely, sensitive rehabilitation of historic storefronts will enhance the character of the overall building and make the storefront more attractive to shoppers.

Significant surviving storefront elements – including windows, sash, doors, transoms, signs and decorative features – shall be retained and repaired. Accurate restorations based on historical research and physical evidence are encouraged. Consistent with encouraging adaptive re-use of

historic buildings, where original or early storefronts no longer exist, or where no evidence exists to document the storefront's original or early appearance, the design of a new storefront shall be compatible with the size, scale, color, material and character of the overall building. Conjectural designs that have no historical basis, or designs that copy traditional features from other buildings, create a false historical appearance and are not allowed.

Avoid inappropriate historical themes on storefront rehabilitations. Small windowpanes, colonial doors and mansard overhangs are examples of stylistic elements that do not belong on most 19th and 20th century storefronts.

Parts of A Traditional Storefront

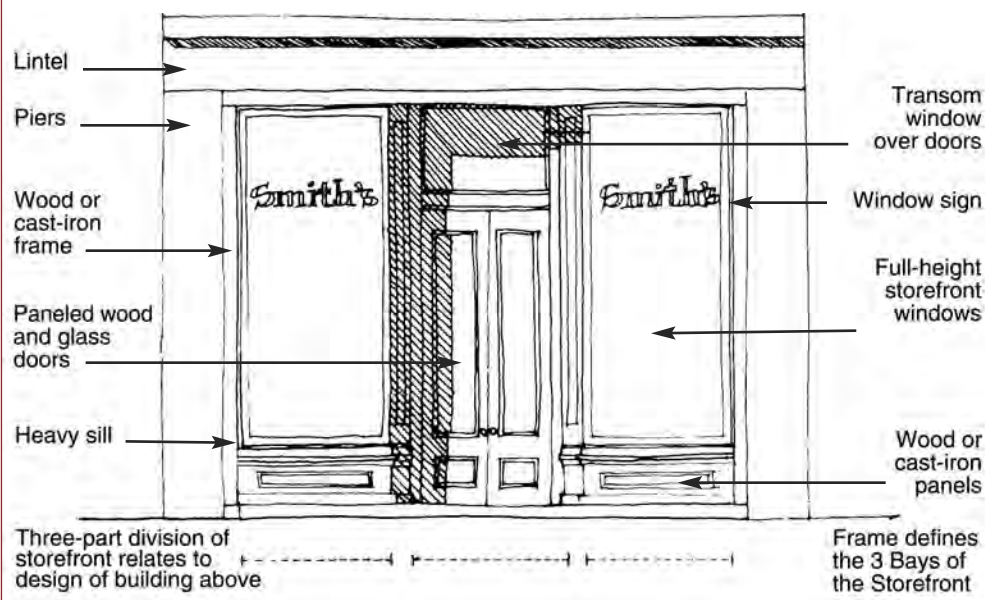

PAINT

Note: The Historic Preservation Commission does not regulate paint colors, but provides assistance on historic paint colors and placement.

A good paint job is fundamental to the preservation of your old building, establishes its architectural personality, and contributes to the overall character of the village. Before you paint your older building consider the underlying reasons for paint wear; proper surface preparation; and an appropriate color scheme.



Prior to repainting, determine if any problems exist that would shorten the life of a new paint job. Moisture problems, incompatible paints, or poor surface preparation may cause paint deterioration. Proper surface preparation is the key to a good paint job. Removing old paint is time consuming but will prevent problems in the years to come. There are basically four recommended removal methods: hand scraping, sanding, burning with a heat gun or plate (but be careful!), and chemical removers.

When choosing a color scheme, first consider the period and style of the building. Where historically authentic colors are desired, microscopic paint analysis will reveal the original and subsequent paint schemes. Paint analysis is best done by a conservator, who will take the samples and interpret the findings. For most paint projects, however, a familiarity with period colors and their placement is sufficient to determine an appropriate color scheme. Fortunately, there are readily available publications on historic paint types and colors. Most major paint manufacturers also offer paint charts illustrating combinations of historic paint colors.



CHOOSING AN APPROPRIATE TREATMENT FOR YOUR HISTORIC BUILDING

The four treatment approaches are Preservation, Rehabilitation, Restoration, and Reconstruction, defined below:

Preservation is defined as the act or process of applying measures necessary to sustain the existing form, integrity, and materials of an historic property. Work, including preliminary measures to protect and stabilize the property, generally focuses upon the ongoing maintenance and repair of historic materials and features rather than extensive replacement and new construction. New exterior additions are not within the scope of this treatment; however, the limited and sensitive upgrading of mechanical, electrical, and plumbing systems and other code-required work to make properties functional is appropriate within a preservation project.

Rehabilitation is defined as the act or process of making possible a compatible use for a property through repair, alterations, and additions while preserving those portions or features which convey its historical, cultural, or architectural values.

Restoration is defined as the act or process of accurately depicting the form, features, and character of a property as it appeared at a particular period of time by means of the removal of features from other periods in its history and reconstruction of missing features from the restoration period. The limited and sensitive upgrading of mechanical, electrical, and plumbing systems and other code-required work to make properties functional is appropriate within a restoration project.

Reconstruction is defined as the act or process of depicting, by means of new construction, the form, features, and detailing of a



non-surviving site, landscape, building, structure, or object for the purpose of replicating its appearance at a specific period of time and in its historic location.

Choosing the most appropriate treatment for a building requires careful consideration about a building's historical significance, as well taking into account its physical condition and proposed use. What is the existing condition—or degree of material integrity—of the building prior to work? Has the original form survived largely intact or has it been altered over time? Are the alterations an important part of the building's history?

Preservation may be appropriate if distinctive materials, features, and spaces are essentially intact and convey the building's historical significance. If the building requires more extensive repair and replacement, or if alterations or additions are necessary for a new use, then Rehabilitation is probably the most appropriate treatment. These key questions play major roles in determining what treatment is selected.

Proposed use. An essential, practical question to ask is: Will the building be used as it was historically or will it be given a new use? Many historic buildings can be adapted for new uses without seriously damaging their historic character; special-use properties such as grain silos, forts, ice houses, or windmills may be extremely difficult to adapt to new uses without major intervention and a resulting loss of historic character and even integrity.

Source: National Park Service, Technical Preservation Services, *The Secretary of the Interior's Standards for Treatment of Historic Properties*, 1995. www.nps.gov/history

ORGANIZATIONS TO GUIDE YOU

LOCAL ORGANIZATIONS

Cranbury Historic Preservation
Commission
23-A North Main Street
Cranbury, New Jersey 08512
(609) 395-0900
www.cranburytownship.org

Cranbury Historical and Preservation
Society
P.O. Box 77
Cranbury, New Jersey 08512
(609) 860-1889
(609) 655-3736

History Center: 6 South Main Street
The Museum: 4 Park Place East
www.cranburyhistory.org

STATE ORGANIZATIONS

Historic Preservation Office
NJ Department of Environmental Protection
P.O. Box 404
Trenton, NJ 08625-0404
(609) 292-2023
www.state.nj.us/dep/hpo

New Jersey Historical Commission
225 West State Street, 4th Floor
Trenton, NJ 08625-0305
(609) 292-6062
www.newjerseyhistory.org

New Jersey Historic Trust
P.O. Box 457
Trenton, NJ 08625-0457
(609) 984-0473
www.njht.org

Preservation New Jersey, Inc.
30 South Warren Street
Trenton, NJ 08608
(609) 392-6809
www.preservationnj.org

NATIONAL ORGANIZATIONS

National Trust for Historic Preservation
1785 Massachusetts Avenue, NW
Washington, D.C. 20036
(202) 588-6000
www.nthp.org

National Park Service
1849 C Street, NW
NC400
Washington, DC 20240
(202) 343-9500
www.nps.gov



PUBLICATIONS

GENERAL REFERENCE WORKS:

Respectful Rehabilitation: Answers to Your Questions about Old Buildings. Technical Preservation Services, U.S. Dept. of the Interior. Washington, D.C.: Preservation Press, 1982.

The Old House Journal Guide to Restoration. Patricia Poore, ed. New York: Penguin Books, 1992.

Fine Homebuilding. Periodical.

Old House Journal. Periodical.

HISTORIC GARDENS AND LANDSCAPES:

American Gardens of the Nineteenth Century. Ann Leighton. Amherst, Mass.: University of Massachusetts Press, 1987.

For Every House a Garden: A Guide for Reproducing Period Gardens. Rudy and Joy Favretti. Hanover, N.H.: The University Press of New England, 1990.

The New Traditional Garden: A Practical Guide to Creating and Restoring Authentic American Gardens for Homes of All Ages. Michael Weishan. New York. Ballentine Books, 1999.



HISTORIC PAINT COLORS:

Century of Color: Exterior Decoration for American Buildings, 1820-1920. Roger Moss. Watkins Glen, N.Y., American Life Foundation, 1981.

Exterior Paint Problems on Historic Woodwork. Kay D. Weeks and David W. Look, A.I.A. Preservation Brief No.10. Technical Preservation Services, U.S. Dept. of the Interior, 1982.

Victorian Exterior Decoration: How to Paint Your Nineteenth Century House Historically. Roger W. Moss and Gail Caskey Winkler. New York, Henry Holt & Co., 1987.

WINDOWS:

Conserving Energy in Historic Buildings. Baird M. Smith. Preservation Brief No.3. Technical Preservation Services, U.S. Dept. of the Interior, 1978.

Repairing Old and Historic Windows: A Manual for Architects and Homeowners. New York Landmarks Conservancy. Washington, The Preservation Press, 1992.

The Repair of Historic Wooden Windows. John H. Myers. Preservation Brief No.9. Technical Preservation Services, U.S. Dept. of the Interior, 1981.

The Repair and Thermal Upgrading of Historic Steel Windows. Sharon C. Park, A.I.A. Preservation Brief No.13. Technical Preservation Services, U.S. Dept. of the Interior, 1991.

VINYL SIDING ON HISTORIC BUILDINGS:

Aluminum and Vinyl Siding on Historic Buildings. John H. Myers, rev. by Gary L. Hume. Preservation Brief No.8. Technical Preservation Services, U.S. Dept. of the Interior, 1984.

GLOSSARY OF ARCHITECTURAL TERMS

Adaptive use – changing an existing, often historic, building to accommodate a new function; may include extensive restoration or renovation and removal of some building elements.

Apron – panel or wide trim under a windowsill.

Architrave – beam running on top of a row of columns; also, moldings around doors and windows.

Asbestos shingle – an exterior shingle composed of cement reinforced with asbestos fibers; popular siding material in the early to mid 20th century.

Asphalt shingle – a shingle composed of rag felt or (after 1970) fiberglass, saturated with asphalt.

Baluster – a spindle or post supporting the railing of a balustrade.

Balustrade – a railing with upper and lower rails and spindles or posts

that is installed on a porch or above a roof cornice.

Bargeboard – decorative or plain trim attached to the eaves of a gable.

Bay – the regular external division of a building marked by windows or other vertical elements (as in a three bay façade). Also an external projecting feature (a bay window).

Bracket – a curved or saw-cut projecting element which supports a horizontal member such as a cornice, window or door hood.

Capital – the top element of a column or pilaster.

Cast iron – molten Iron that is poured into a mold to achieve a design.

Classical – pertaining to the architecture of Greece and Rome, and to the styles inspired by this architecture (Georgian, Greek Revival, Neoclassical).

Column – a vertical pillar or shaft, usually supporting a member above.

Corner Boards – mitered or butted vertical trims at the junction of two walls.

Cornice – a projecting molding at the top of a roof, wall or other element.

Cupola – a small structure projecting above the roof that provides ventilation or is used as a lookout.

Dentil – molding composed of equally spaced rectangular blocks; from the French for tooth.

Dormer – A small window with its own roof projecting from a sloping roof.

Eave – the projecting overhang at the lower edge of a roof.

Façade – the front face or elevation of a building.

Fanlight – semicircular window with radiating muntins, often placed over a door or window.

Fascia Board – trim covering rafter ends at the end of a roof pitch.

Finial – projecting ornamental element at the top of a gable, spire or pointed roof.

Frieze – the middle part of the deep flat boards under a classical cornice.

Gable Dormer – gable-ended structure with a window that projects from a roof.

Gable roof – a roof with a central ridgepole and one slope at each side. A gable is the triangular section of wall under the roof edge.

Gambrel roof – a roof with a central ridgepole and two sloping roof sections.

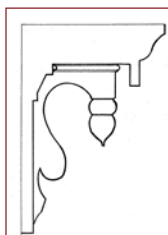
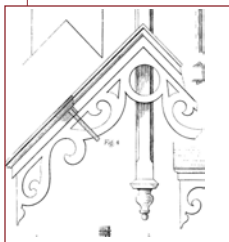
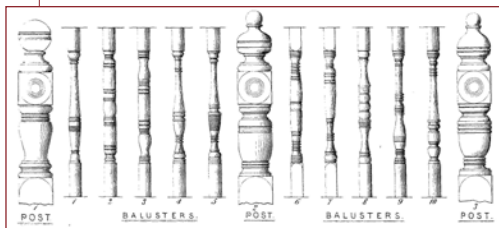

GLOSSARY OF ARCHITECTURAL TERMS

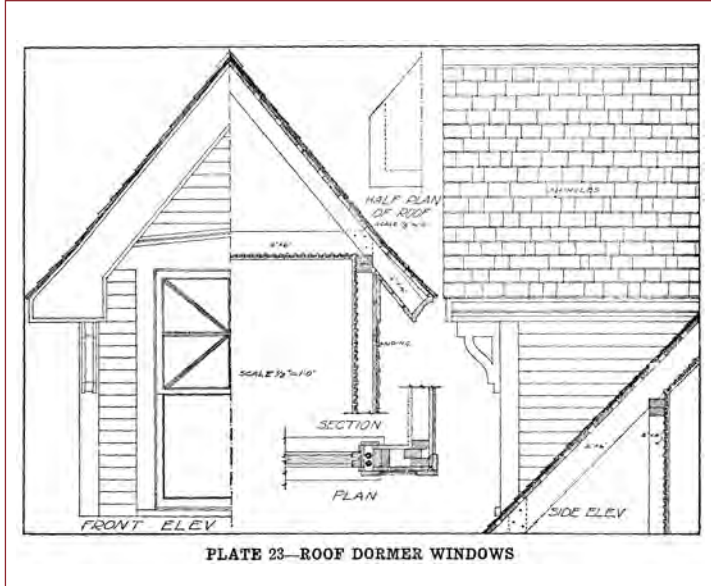

Hip roof – a roof with uniform slopes on all four sides of a building.

Hood – shallow overhang above a door or window.

Lattice – open work produced by interlacing of laths or other thin strips of wood used as screening, often on the base of a porch or on fencing.

Leaded glass window – composed of pieces of glass that are held in place with lead strips; the glass can be clear, colored, or stained.

Light – transparent portion of a window; also, single pane of glass.

Mansard roof – a roof having a double slope on all four sides, the lower slope being much steeper than the upper slope.

Meeting Rail – top member of lower sash and bottom member of upper sash in double-hung window.

Modillion – an ornamental horizontal block or bracket placed under the overhang of a cornice.

Mullion – a vertical divider in a window.

Muntin – the wood dividing strips between the panes or “lights” in a multi-paned window.

Newel – Decorative structural post at either end of a stair rail. The post at the top or bottom of a flight of stairs, supporting the handrail.

Newel Cap – Decorative element atop a newel.

Palladian Window – assembly of windows in which two lights flank one with an arched top.

Parapet – low wall or barrier railing at a balcony or roof edge.

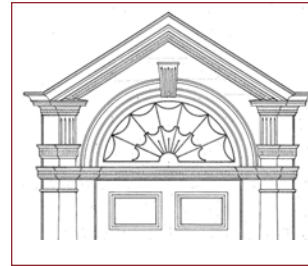

Pediment – the triangular gable end of a roof; also, any similar crowning element used over doors and windows, usually triangular but may be curved.

Pier – load-bearing element that rises from a footing.

Pilaster – A shallow pillar attached to a wall, resembling a classical column; used commonly on windows and doors.

Portico – a columned entrance porch.

Preservation – 1. the protection of a material from physical deterioration or disintegration because of natural elements or human activity by various technical, scientific, or craft techniques. 2. the process of protection and enhancement of historic sites, structures, and objects.

Rail – horizontal structural member of a door or sash.

Raking Cornice – molding that follows the slope of a pediment or gable.

Reconstruction – the process of duplicating the original form, materials and appearance of vanished building or structure at a particular historical moment through historical research.

GLOSSARY OF ARCHITECTURAL TERMS

Rehabilitation – the act or process of returning a property to a state of utility through repair or alteration which makes possible an efficient contemporary use while preserving those features which are historically significant.

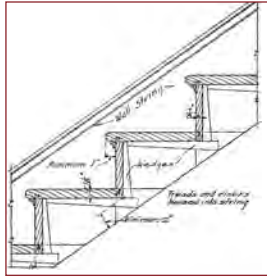

Restoration – the process of product of returning an existing site, building, structure or object to its condition at a particular time in its history.

Riser – vertical part of a stair step.

Sash – the frame in which a window is set; may be moveable or fixed; may slide vertically (as in double-hung window) or pivot (as in casement window).

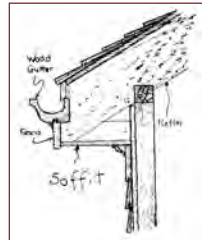

Sill – the lower horizontal member of a door frame, window frame or wall.

Soffit – the exposed underside of any overhead component of a building, such as the undersurface of an arch, cornice, eave, or stairway.

Spindled Frieze – band of spindles attached under the eaves of a porch.

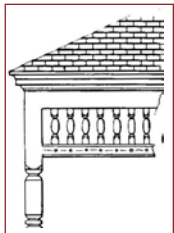

Stile – vertical structural member of a door or sash.

Transom – windows or panels, usually operable, above a window or door.

Transom light – a small window over a door or another window; may be rectangular, fan-shaped or elliptical.

Tread – horizontal part of a stair step.

Turret – curved projection with windows, often topped with a conical roof.

Water Table – horizontal drip-edge that prevents water from running down a wall.

Wrought Iron – heating iron until it can be hand beaten and twisted into a design.

Source: *Dictionary of Building Preservation*, ed. Ward Bucher (John Wiley & Sons, 1996)



Cranbury Township Historic Preservation Commission

Cranbury Town Hall

23-A North Main Street, Cranbury, New Jersey 08512

www.cranburytownship.org